

JL Spacer series



JL Spacer



JL Spacer(Ntype)



WT Spacer



NS Spacer

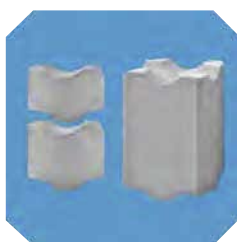

FBS Spacer

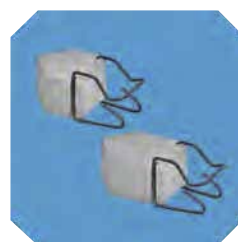

JL Spacer(Gtype)

JL Spacer PAT.

Product features

- Have strong adhesivity to concrete as it uses same material.
- It has strong compressive strength which is more than 70N/mm², so it is recommended to use for prestressed concrete.
- Have strong solidity that can reduce the number of spacer that let reduce total costs.
- No deformation even by high temperature or degree of front, prevent crack on surface.
- It will be point contact with the mold so the appearance of concrete surface is very clean

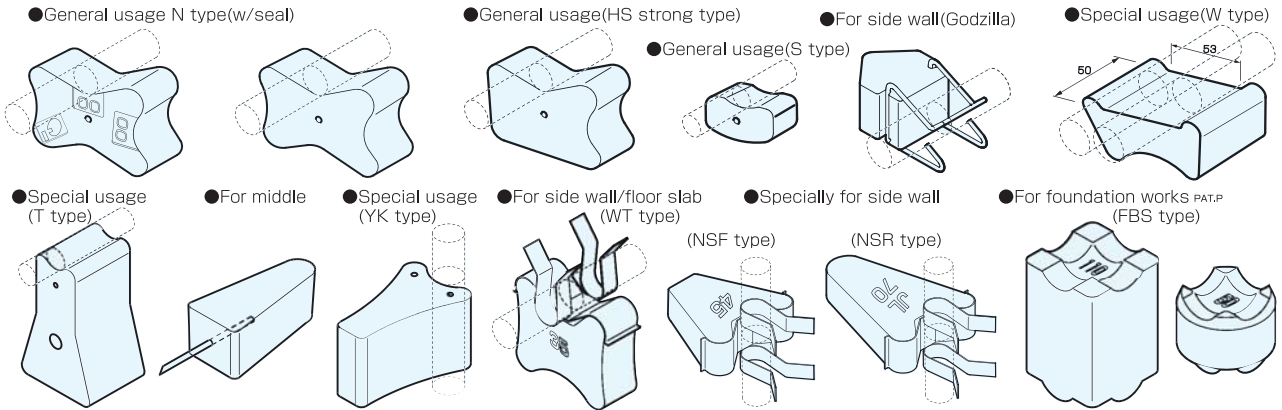

■ General usage

JL spacer(N type has seal)

Enable to take couple kind of concrete covering. Have seal of cover depth at side.

The narrow part prevent drop.

Contact with curved part so surface appearance is clear.

■ For side wall/floor slab

G type (Godzilla)

WT type

NS-R type(for side wall)

NS-F type (for side wall)

Easy to install into arrangement of bars by clip.

■ For foundation works

FBS type

■ WT type (Steel part is not included within the covering depth)
WT type concrete spacer made by high intensity concrete that have adequate strength.

(Unit: mm)

Form	Covering dimension	Load limit	Form	Covering dimension	Load limit	Form	Covering dimension	Load limit	Compatible steel bar
30WT	30	250kg以下	70WT	70	1000kg以下	130WT	130	1000kg以下	diameter of bar 10, 13, 16, 19, 22, 25, 29, 32, 35, 38, 41, 51
35WT	35	500kg以下	80WT	80	1000kg以下	140WT	140	1000kg以下	
40WT	40	700kg以下	90WT	90	1000kg以下	150WT	150	1000kg以下	
45WT	45	700kg以下	100WT	100	1000kg以下				
50WT	50	900kg以下	110WT	110	1000kg以下				
60WT	60	900kg以下	120WT	120	1000kg以下				

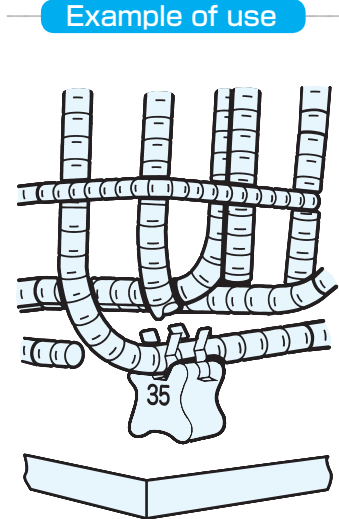

* スペースの脱落や転倒を防止するため、鉄筋径に合わせてそれぞれ専用のクリップをセットしています。

JL Spacer PAT.P

■ FBS Spacer PAT.P (High intensity spacer for foundation works)

Product Features

- By combining two spacers to support many cover dimensions requirement.
- The uneven shape provide stability when combine two spacers.
- Maximum size available is 460mm cover dimensions.
- Concave part of FBS spacer can be correspond to the steel bar and maximum diameter is D51.

◀ Example of stack ▶

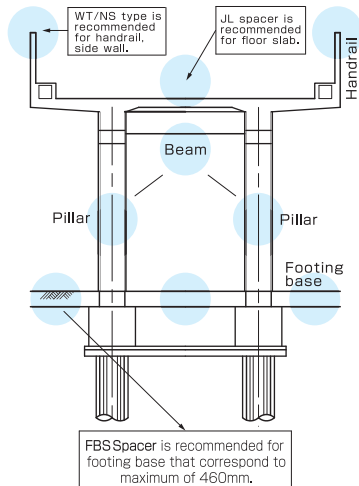
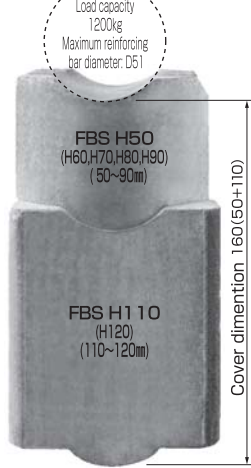

■ NS Spacer (High intensity spacer for side wall)

Product Features

- Secure no iron/organic matter within cover dimension area.
- Easy installation to reinforcement rods.
- Clip is detachable and can do special coating as per request.
- The appearance of concrete surface when removed from mold is clear. (R type)
- Light weight that help prevent drop when mounting form work.

Standard view

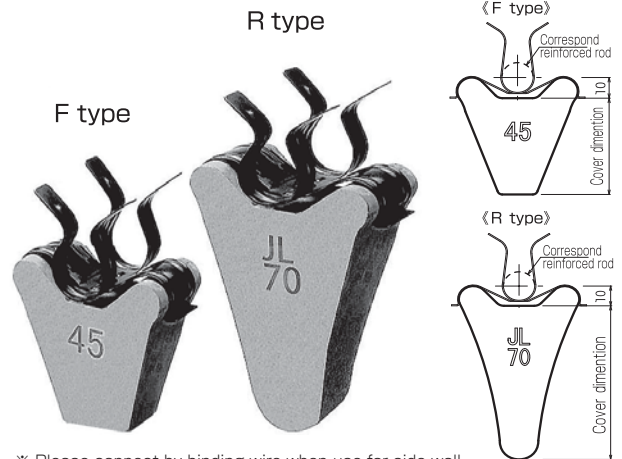

※ Please connect by binding wire when use for side wall.

Application	Type	Part code	cover dimension(mm)	case pack(pcs)	Application	Type	Part code	cover dimension(mm)	case pack(pcs)	Application	Type	Part code	cover dimension(mm)	case pack(pcs)
For floor slab	General usage	S15	15	1000	For floor slab/side wall	WT type (w/clip, specify rod diameter)	130WT	130	50	Specially for side wall	NS type (w/clip, specify rod diameter)	70NSR	70	200
		2025N	20,25	750			140WT	140	50			80NSR	80	100
		3035N	30,35	500			150WT	150	50			90NSR	90	100
		4050N	40,45,50	250			190WT	190	50			100NSR	100	100
		5560N	55,60	150			G3010	30	500			110NSR	110	100
		6570N	65,70	100			G3013	30	500			120NSR	120	100
		7580N	75,80	100			G3016	30	450			130NSR	130	100
		*8590N	85,90	100			G3019	30	350			25NSF	25	200
		9100N	90,100	50			G3510	35	450			30NSF	30	200
	YK type	*YK-100	100	-			G3513	35	450			35NSF	35	200
T type	*T-110	110	40	G3516	35	400	40NSF	40	200					
	*T-120	120	40	G3519	35	300	45NSF	45	200					
Strong type	*HS335	30,35	350	G4010	40	400	50NSF	50	200					
	*HS450	40,50	150	G4013	40	400	60NSF	60	200					
Special usage	*W350	35	100	G4016	40	400	70NSF	70	200					
For middle	*H120	120	40	G4019	40	250	80NSF	80	100					
For floor slab/side wall	WT type (w/clip, specify rod diameter)	30WT	30	200	G4510	45	350	90NSF	90	100				
		35WT	35	200	G4513	45	350	100NSF	100	100				
		40WT	40	200	G4516	45	350	110NSF	110	100				
		45WT	45	200	G4519	45	250	120NSF	120	100				
		50WT	50	200	G5010	50	350	130NSF	130	100				
		60WT	60	100	G5013	50	350	FBS-H40	40	45				
		70WT	70	100	G5016	50	300	FBS-H50	50	45				
		80WT	80	100	G5019	50	250	FBS-H60	60	45				
		90WT	90	100	35NSR	35	200	FBS-H70	70	30				
		100WT	100	50	40NSR	40	200	FBS-H80	80	30				
		110WT	110	50	45NSR	45	200	FBS-H90	90	30				
		120WT	120	50	50NSR	50	200	FBS-H110	110	15				
			60NSR	60	200	FBS-H120	120	12						

* These are not standard inventory. Please check inventory. Please order as per case pack quantity.



Japan Life Co., Ltd.
ジャパンライフ株式会社
<http://www.japanlife.co.jp>